

TOP VIEW

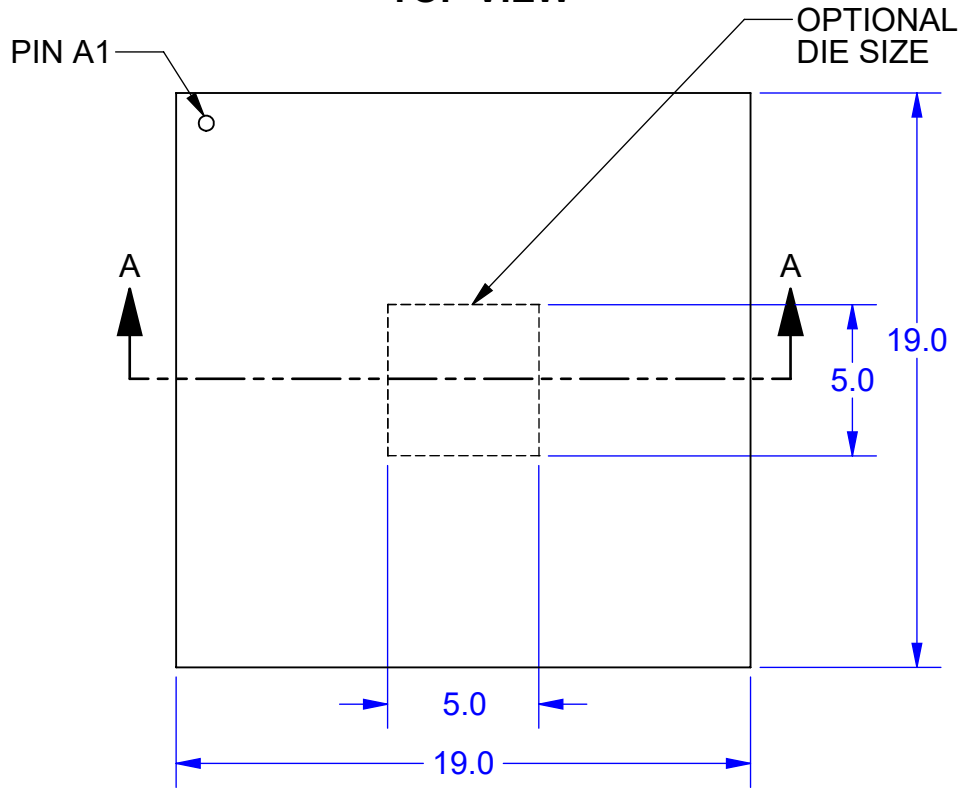

BALL VIEW

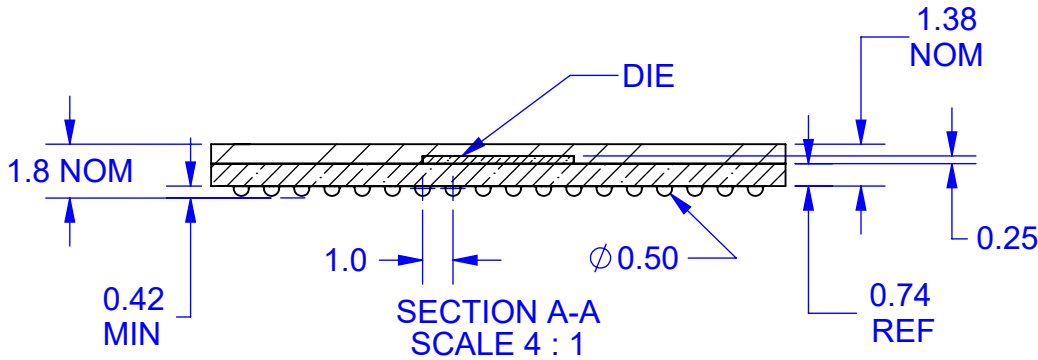
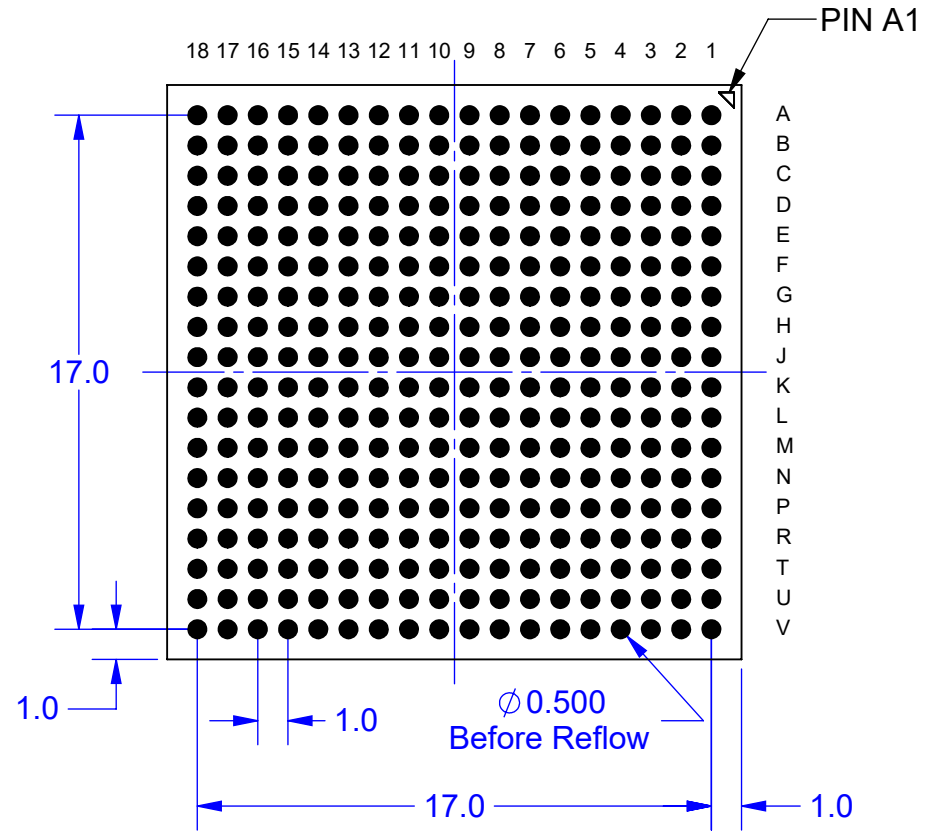

Notes: (Unless Otherwise Specified).

- 1) ALL DIMENSIONS ARE IN MM.
- 2) SOLDER BALL ALLOY: SEE PART NUMBER TABLE.
- 3) BALL DIAMETER (BEFORE REFLOW): $\phi 0.50\text{mm}$ (20 MIL).
- 4) SOLDER MASK DEFINED PAD OPENING: $\phi 0.457\text{mm}$ (18 MIL).
- 5) PAD Cu DIAMETER: $\phi 0.60\text{mm}$ (24 MIL).
- 6) SUBSTRATE MATERIAL: BT.
- 7) DIE SIZE IS OPTIONAL.
- 8) BALL PATTERN (SEE PAGE 2).
- 9) MSL-3 RECOMMEND BAKING 24 HOURS @ 125C TO REMOVE MOISTURE PRIOR TO SOLDERING TO PC BOARD.

PART NUMBER TABLE

PART NUMBER	BALL ALLOY	BALL CODE	RoHS	Si DIE
BGA324T1.0C-DC189D	Sn96.5/Ag3.0/Cu0.5	SAC305	YES	YES
BGA324T1.0Q-DC189D	Sn-Ag-Cu-Bi-Ni	SAC-Q	YES	YES
BGA324T1.0-DC189D	Sn63/Pb37	Sn63	NO	YES

APPROVALS		DATE				
DRAWN	T. Au	10/20/2022				
ENG	M. Hart	10/20/2022	MFG			
QA			SCALE	SIZE	DRAWING NO.	REV
CUST			4:1	A	511803	A
REVISED			DO NOT SCALE DRAWING			SHEET 1 OF 4

BALL VIEW

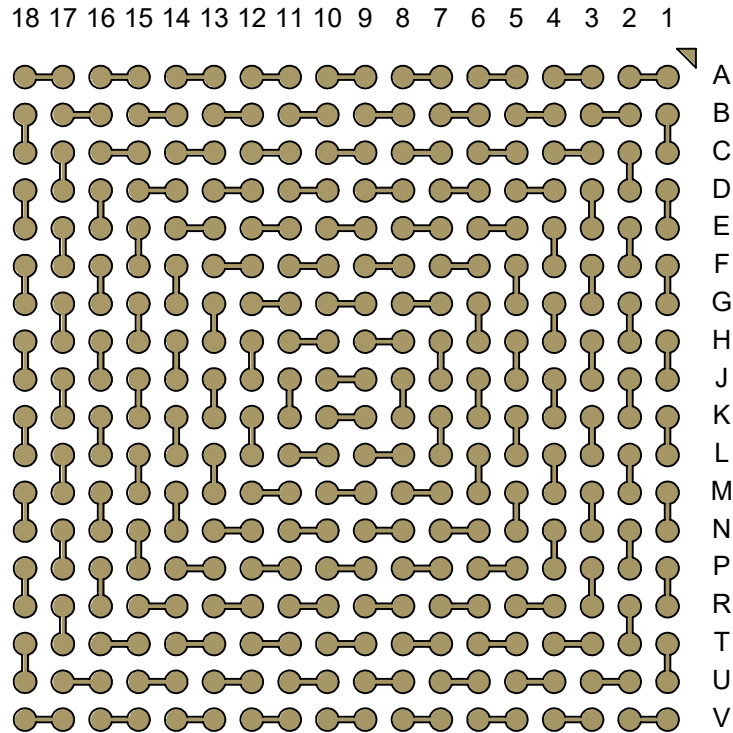

BOTTOM SIDE (TOP X-RAY VIEW)

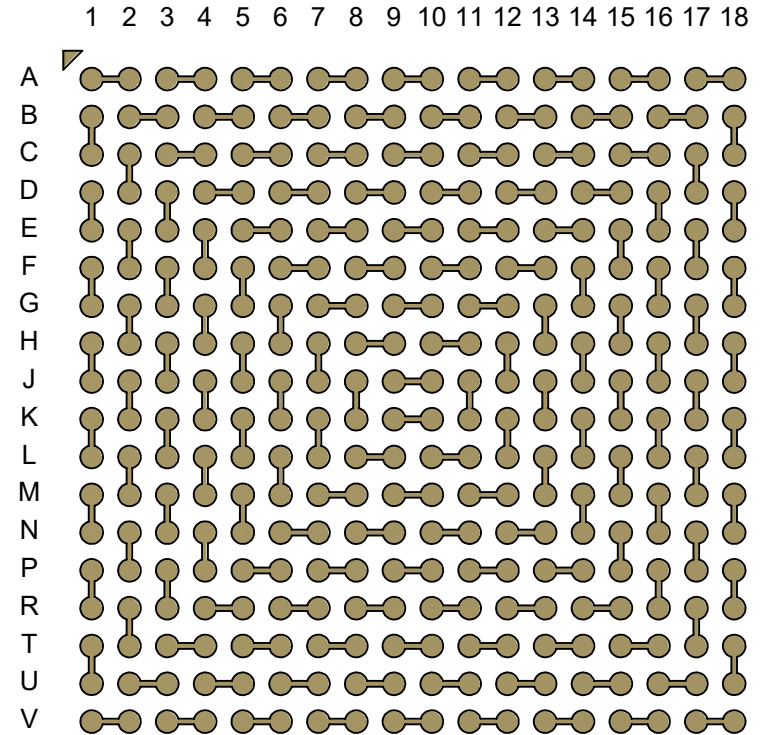

Notes:

- 1) PCB BOARD DIMENSIONS ARE PRESENTED ONLY AS A GUIDELINE. DESIGNERS SHOULD USE THEIR OWN EXPERIENCE WHEN DESIGNING PCB.
- 2) PCB Cu BALL PAD DIAMETER: $\varnothing 0.60\text{mm}$ (24 MIL).
- 3) PCB DAISY CHAIN TRACING LINE WIDTH: 0.152mm (6 MIL).
- 4) SMD (SOLDER MASK DEFINED) PAD OPENING: $\varnothing 0.457\text{mm}$ (18 MIL).

TopLine®

TITLE BGA324T1.0-DC189D
DAISY CHAIN DUMMY

SCALE	SIZE	DRAWING NO.	REV
5:1	A	511803	A

DO NOT SCALE DRAWING

SHEET 2 OF 4

MODEL

TOP

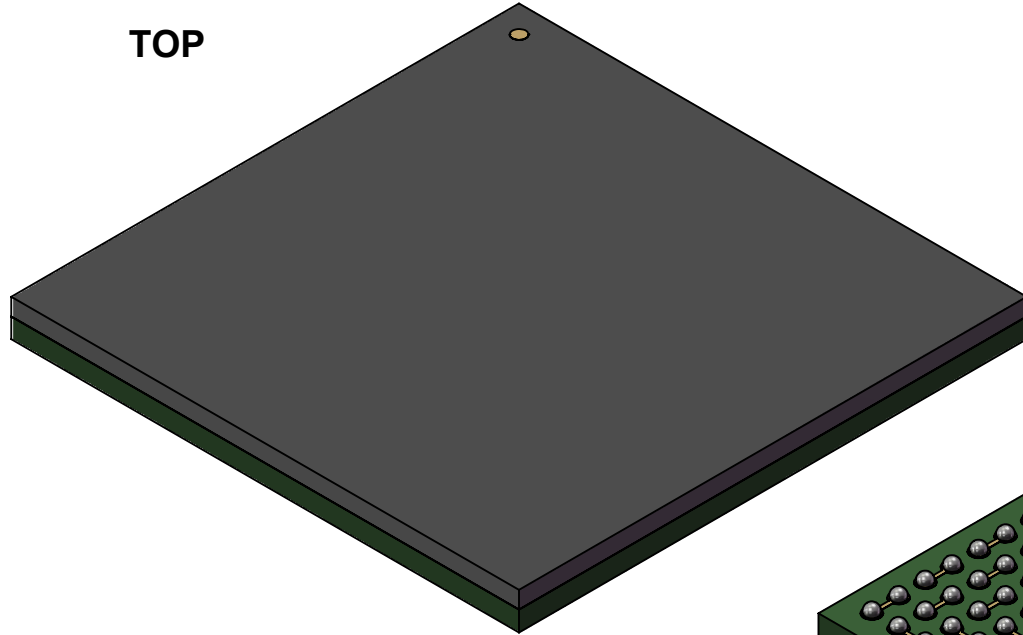

BOTTOM

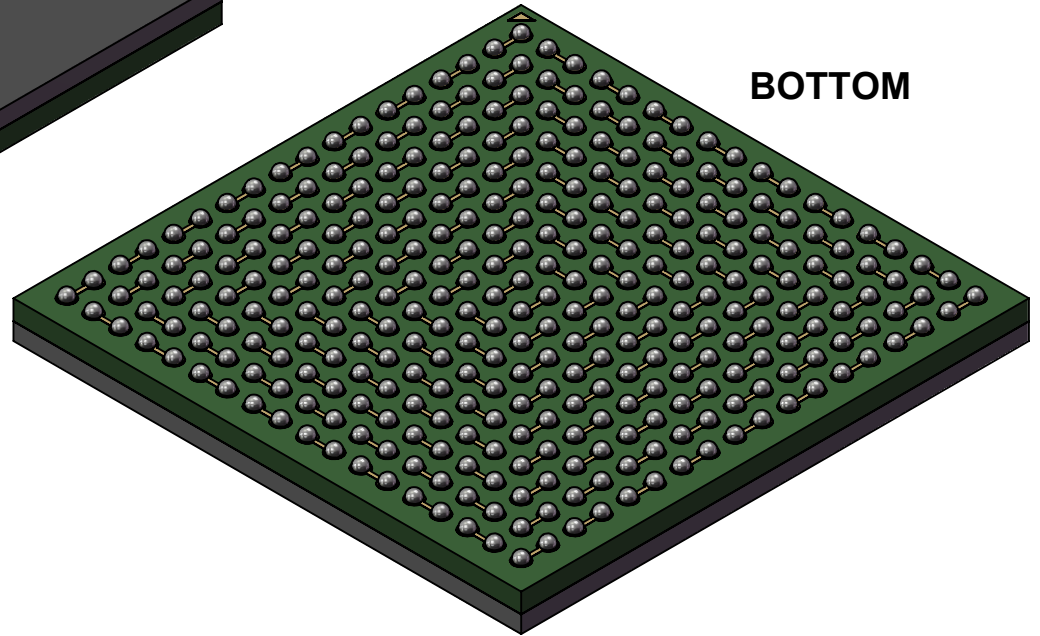

TopLine[®]

TITLE BGA324T1.0-DC189D
DAISY CHAIN DUMMY

SCALE 5:1	SIZE A	DRAWING NO. 511803	REV A
--------------	-----------	-----------------------	----------

DO NOT SCALE DRAWING

SHEET 3 OF 4

BOTTOM SOLDER MASK (RIGHT READING)

18 17 16 15 14 13 12 11 10 9 8 7 6 5 4 3 2 1

A
B
C
D
E
F
G
H
J
K
L
M
N
P
R
T
U
V

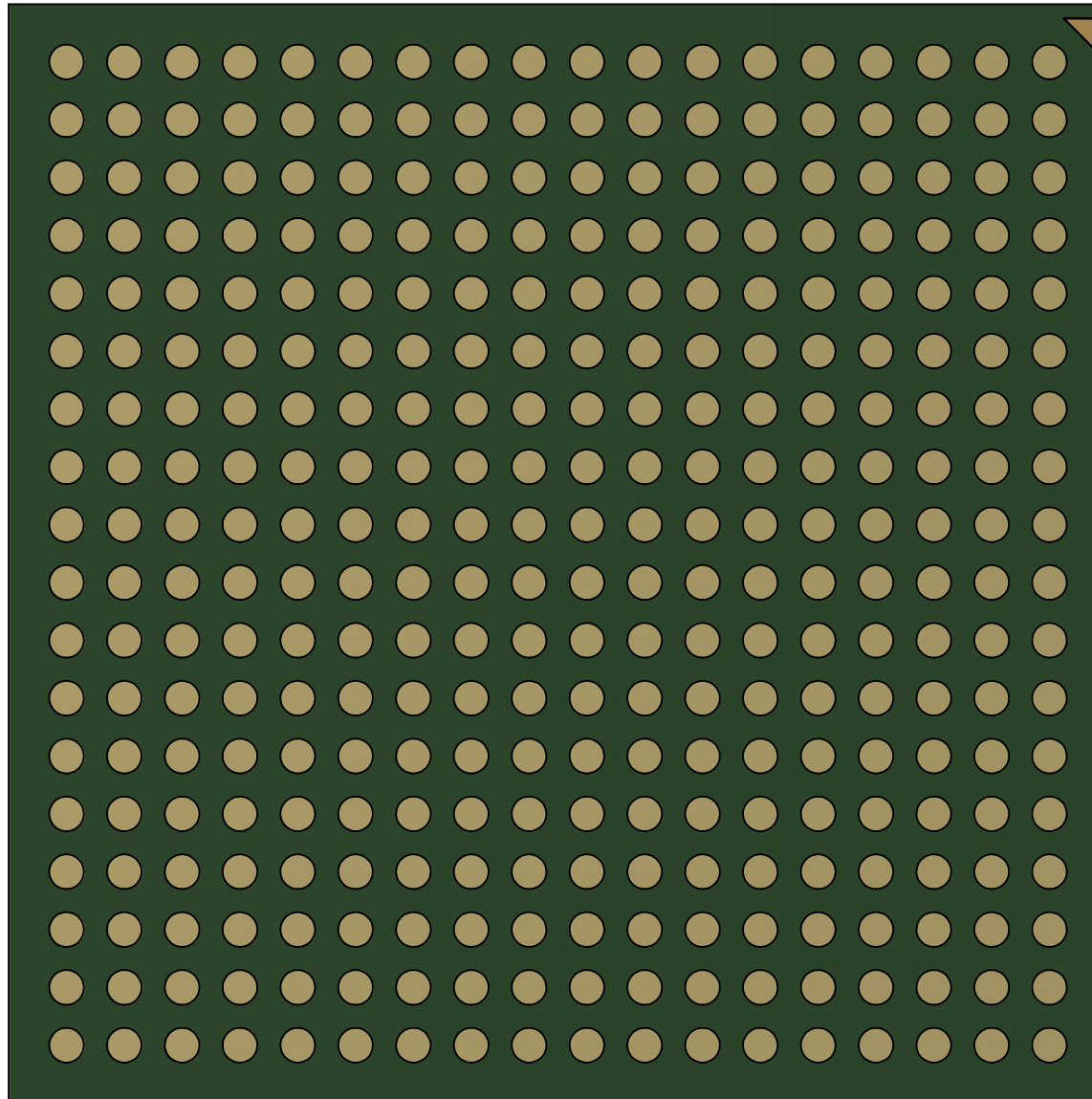

TopLine[®]

TITLE BGA324T1.0-DC189D
DAISY CHAIN DUMMY

SCALE 5:1	SIZE A	DRAWING NO. 511803	REV A
--------------	-----------	-----------------------	----------

DO NOT SCALE DRAWING

SHEET 4 OF 4